

**collatéraux gauche et droite  
et façade...**

pas de difficultés particulières

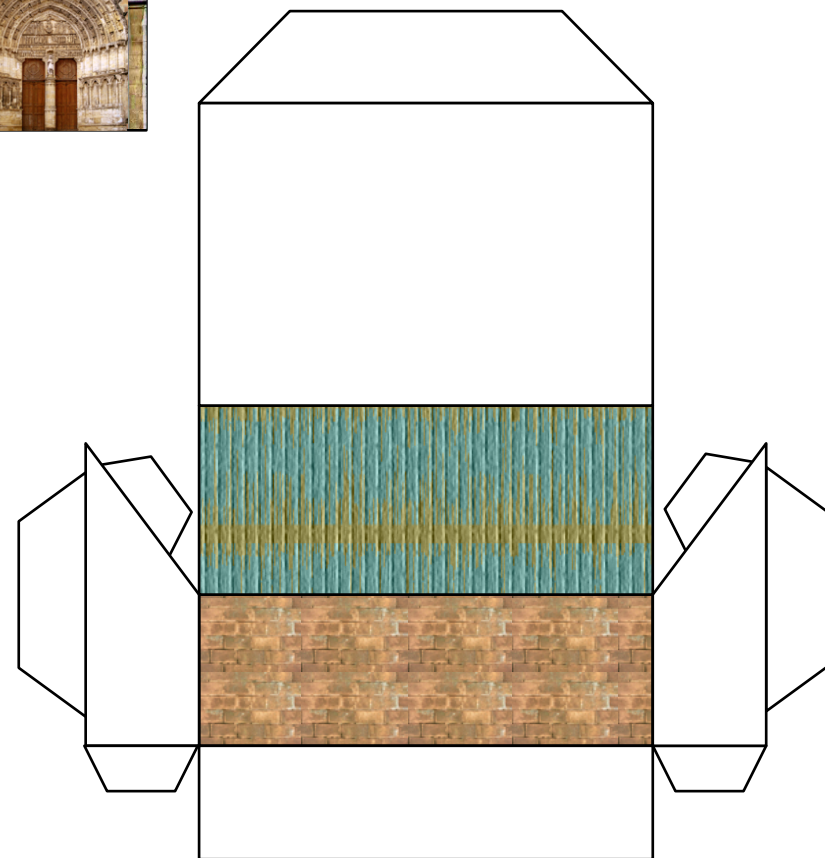

# Nef

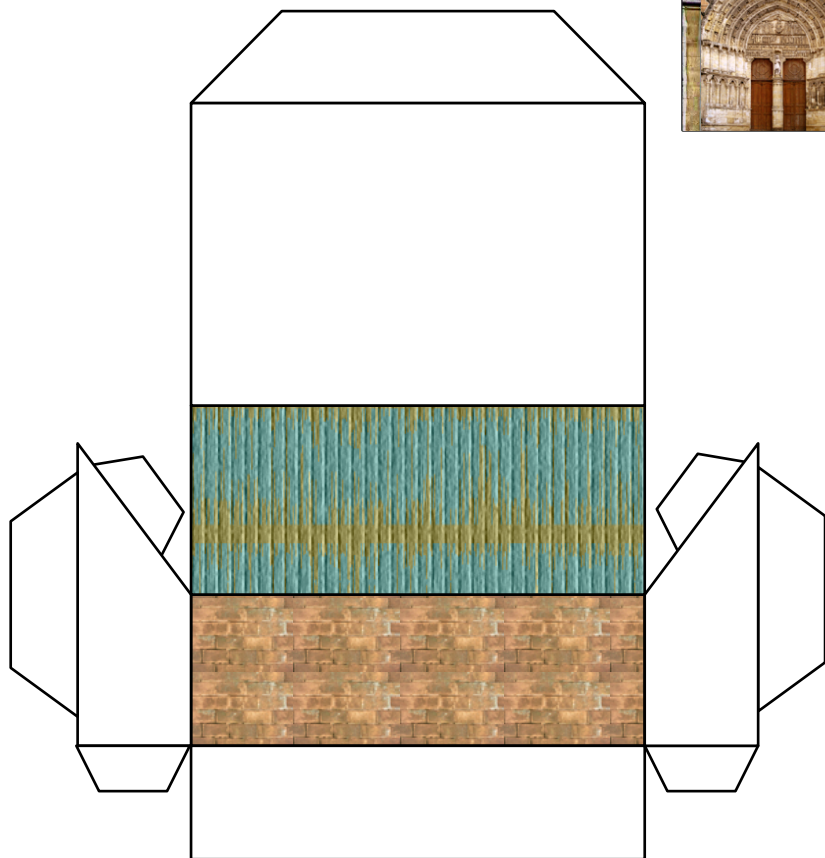
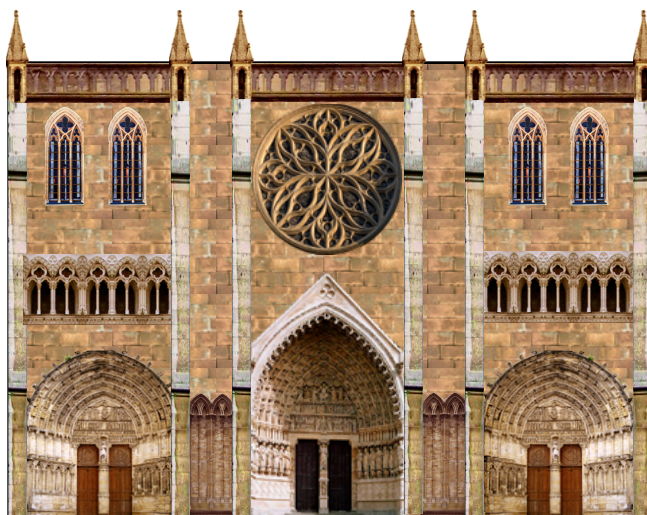
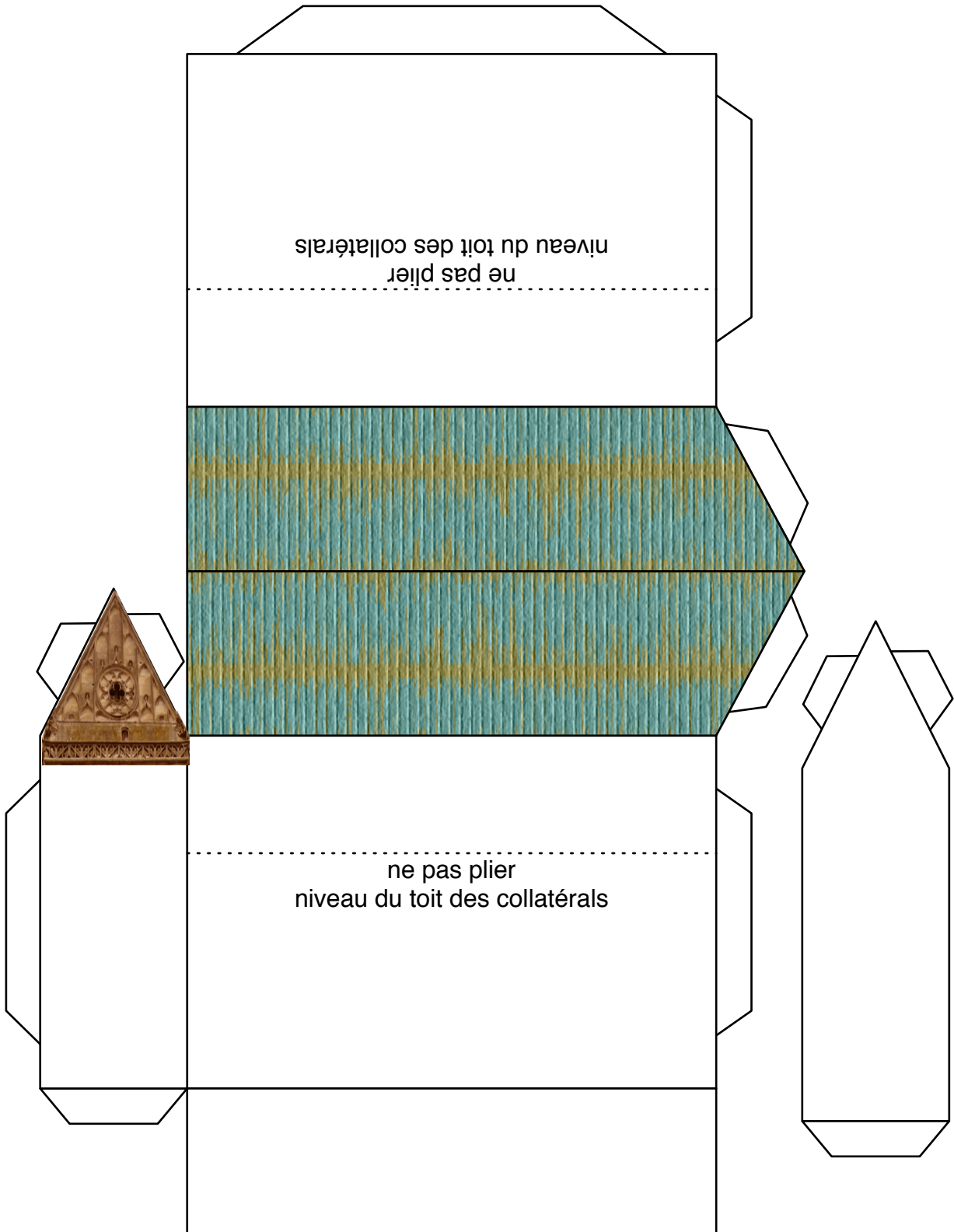

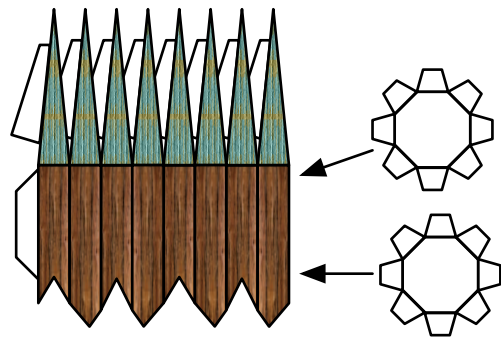
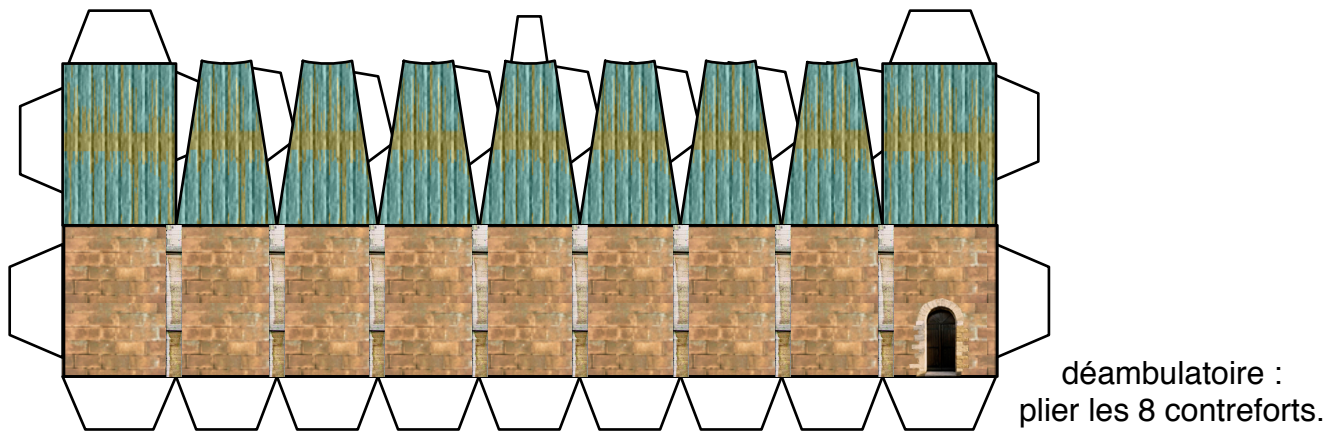
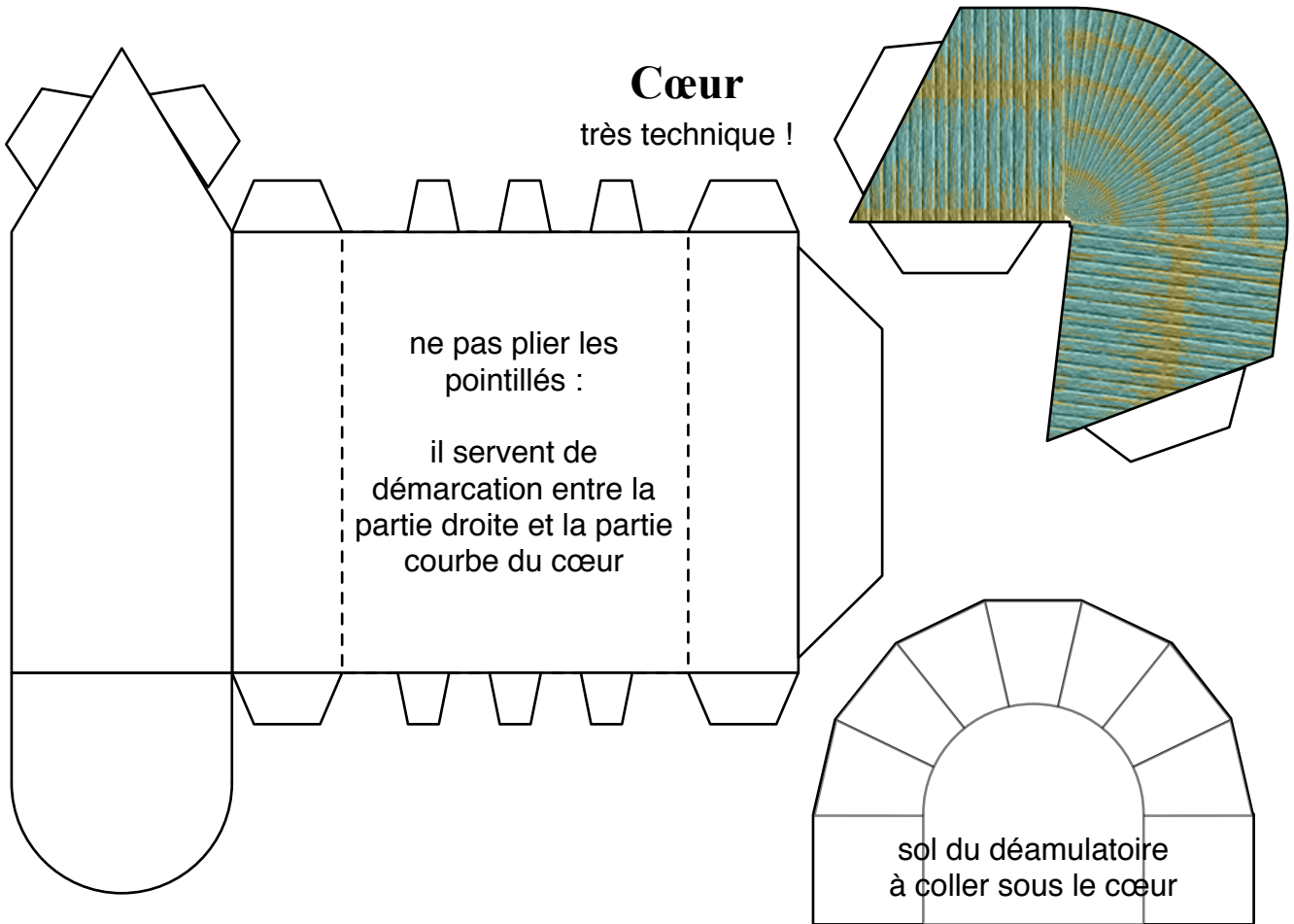

# Transept

pas de difficultés particulières

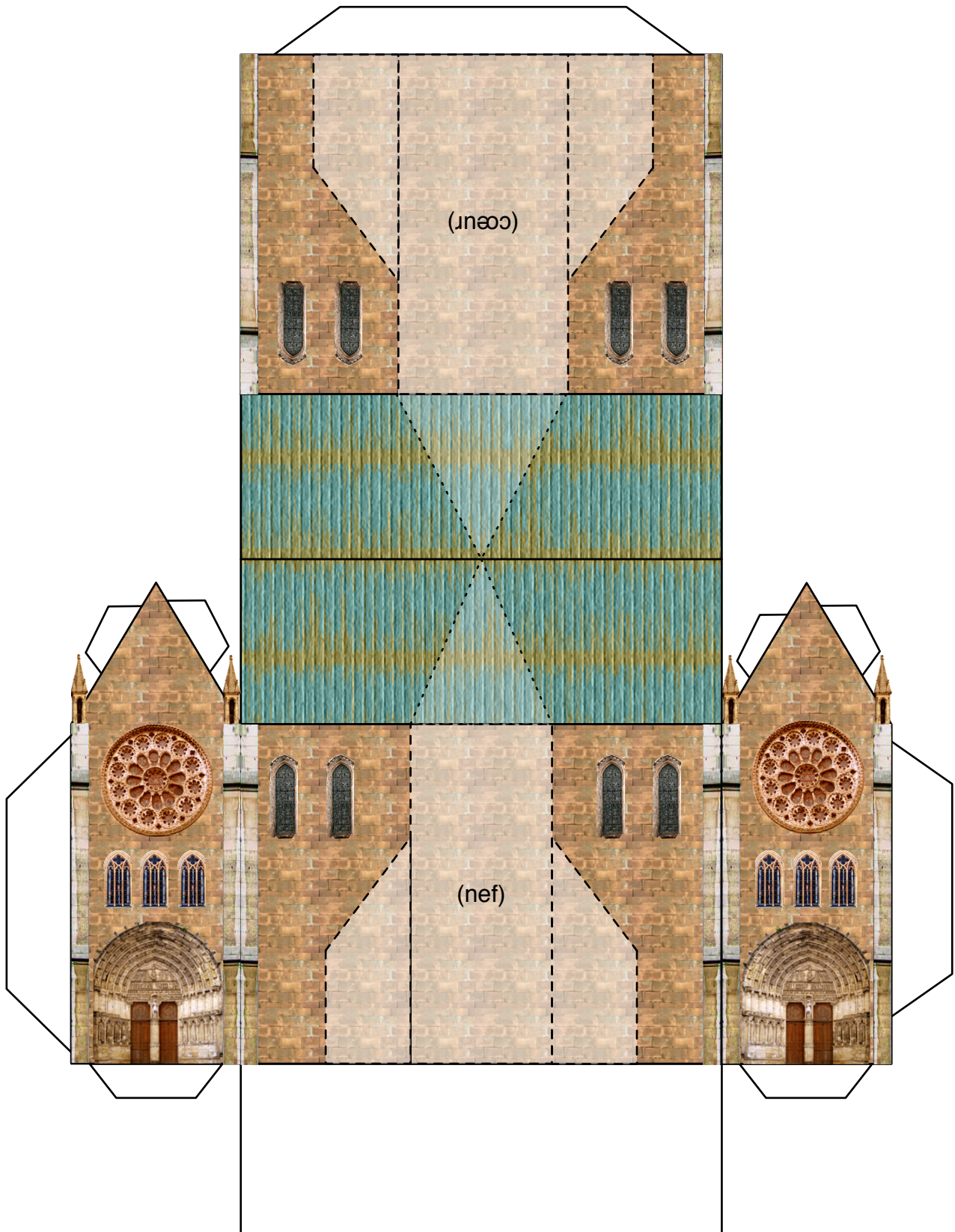

# tours des clochers

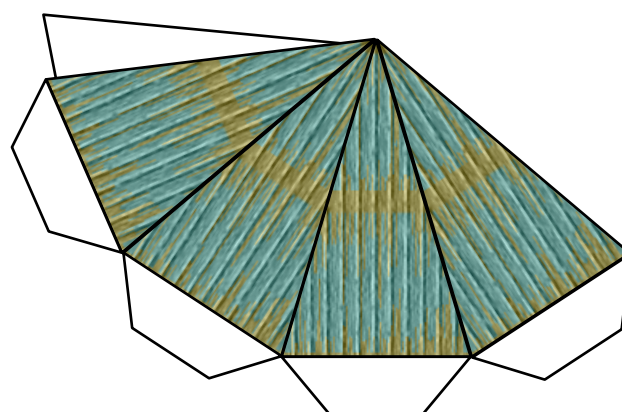
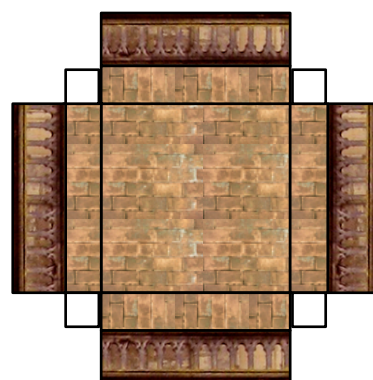
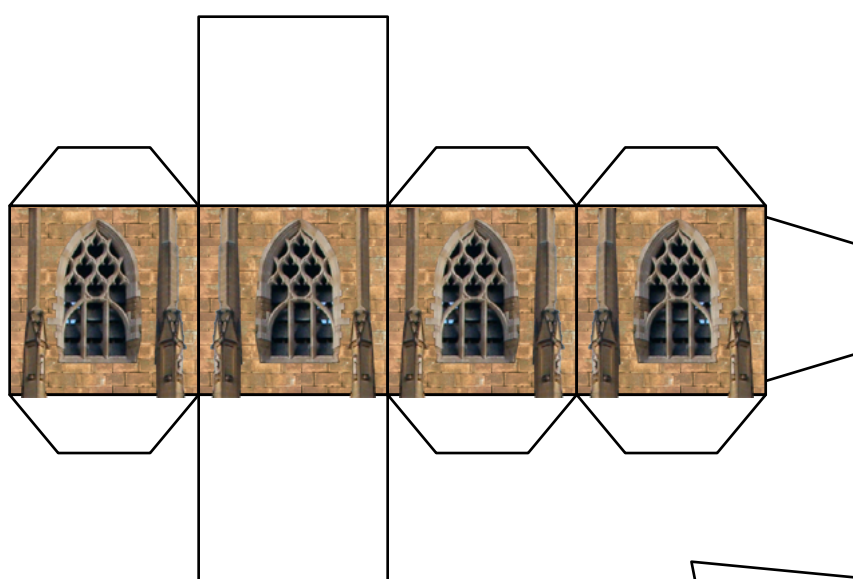
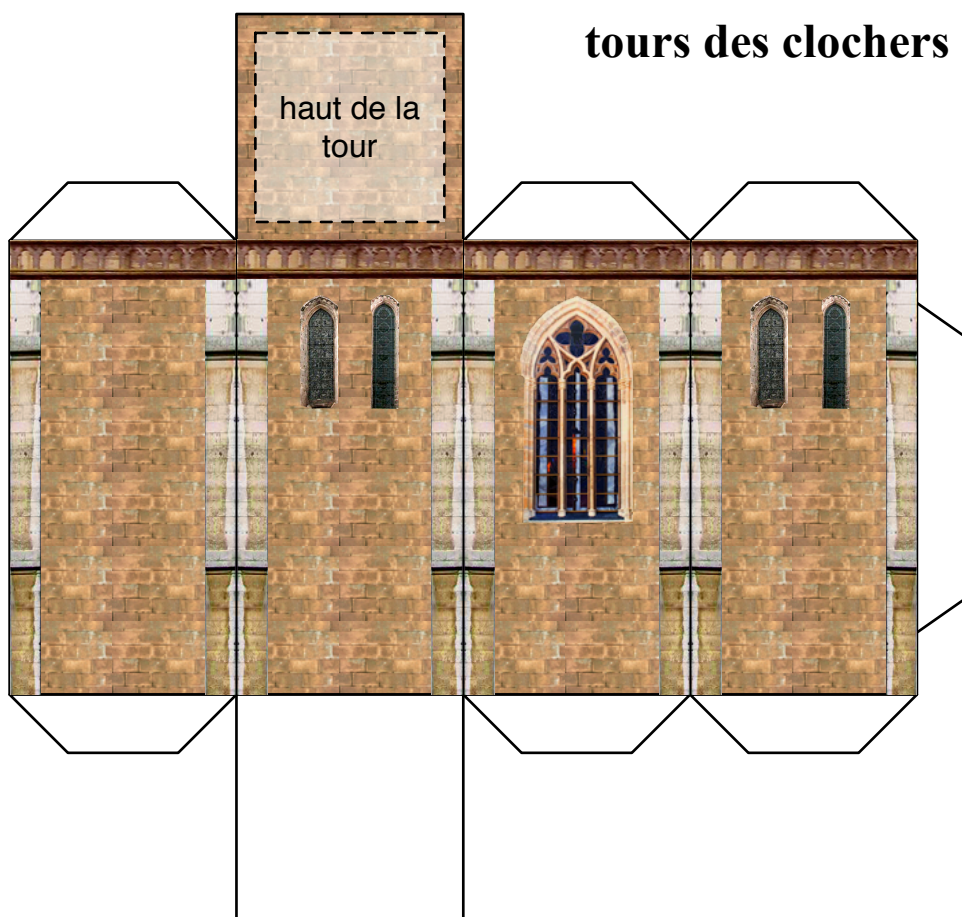

# tours des clochers

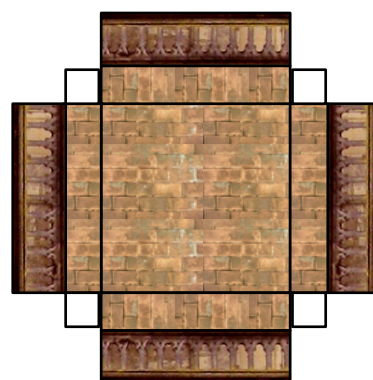
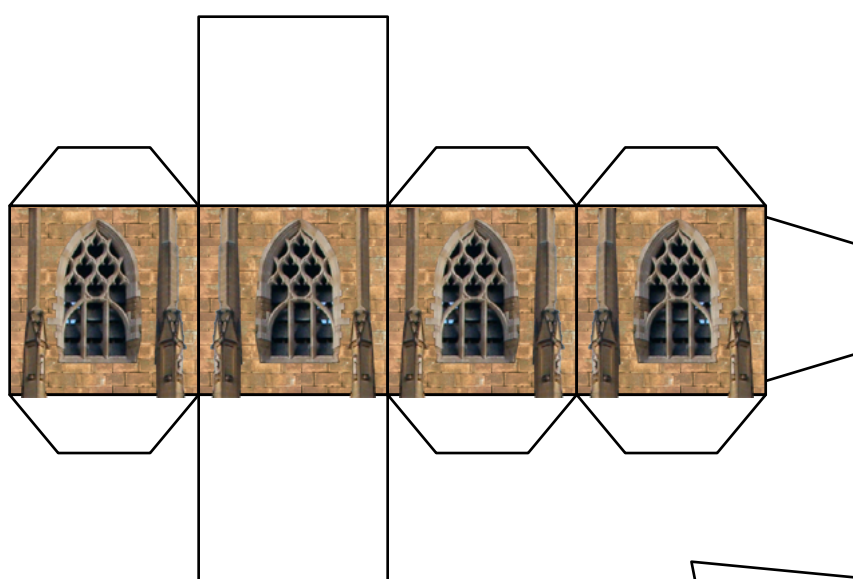
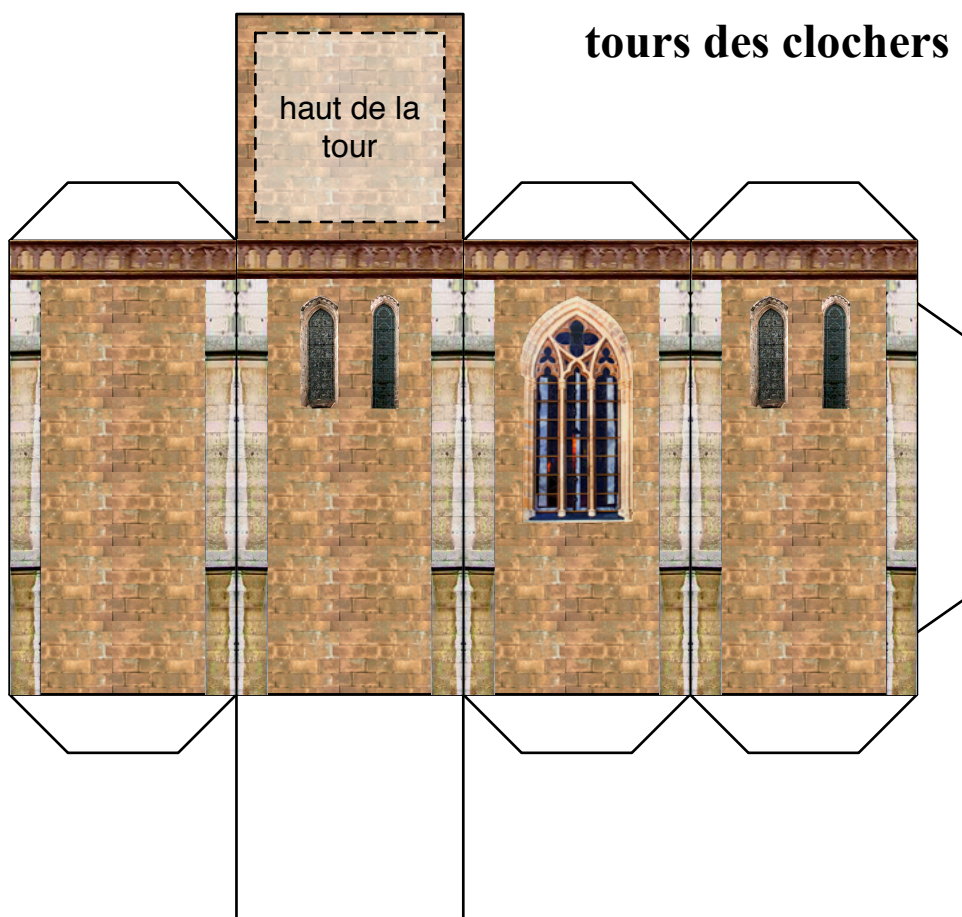

terrace : plier vers l'intérieur puis replier les bords vers l'extérieur

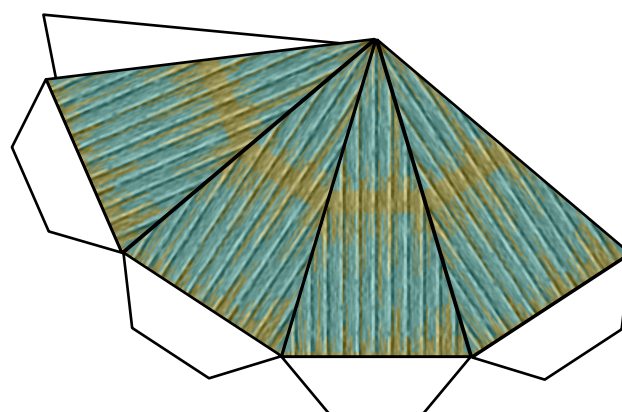

# Plan général de la maquette

échelle 1:1

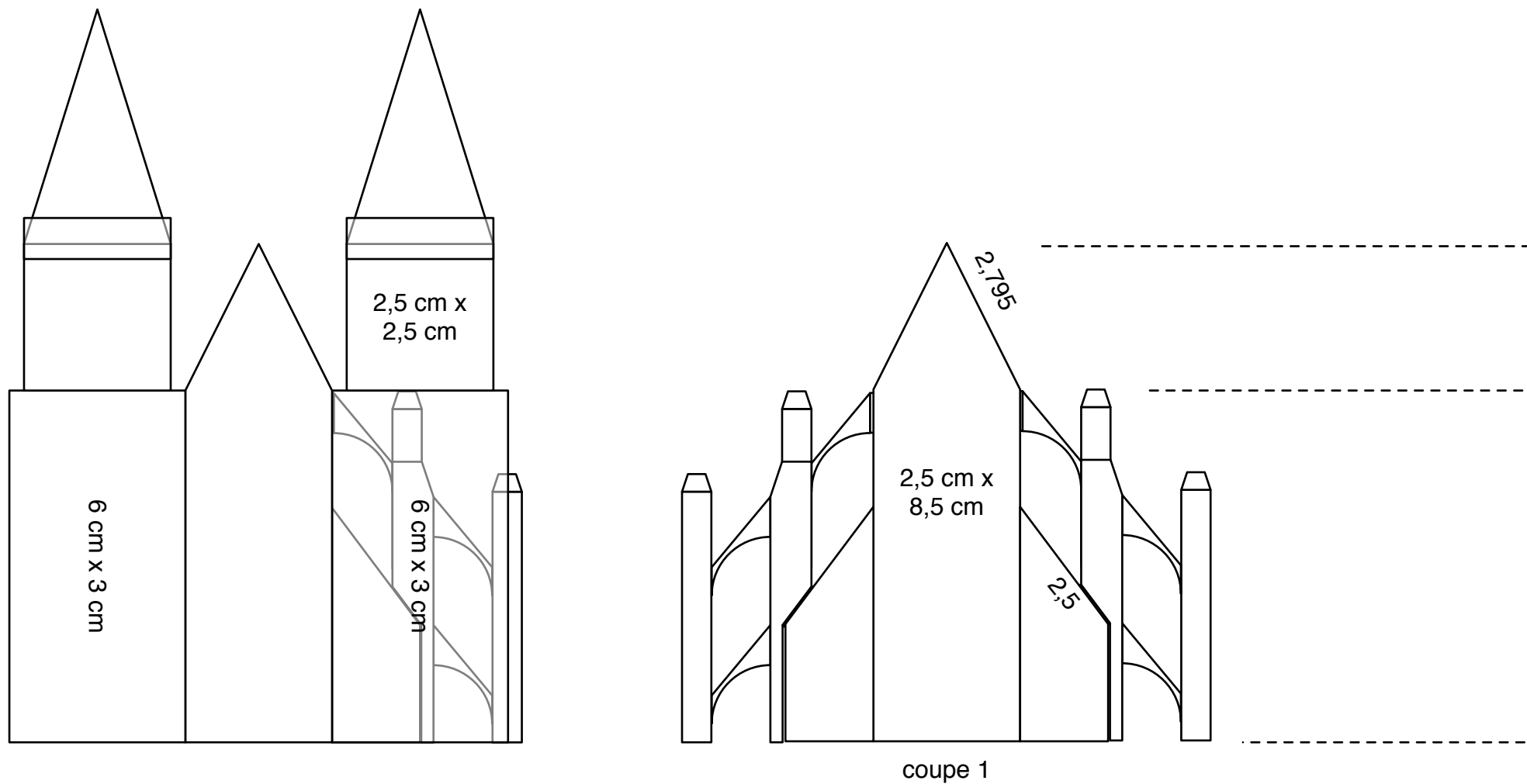

coupe 1

